

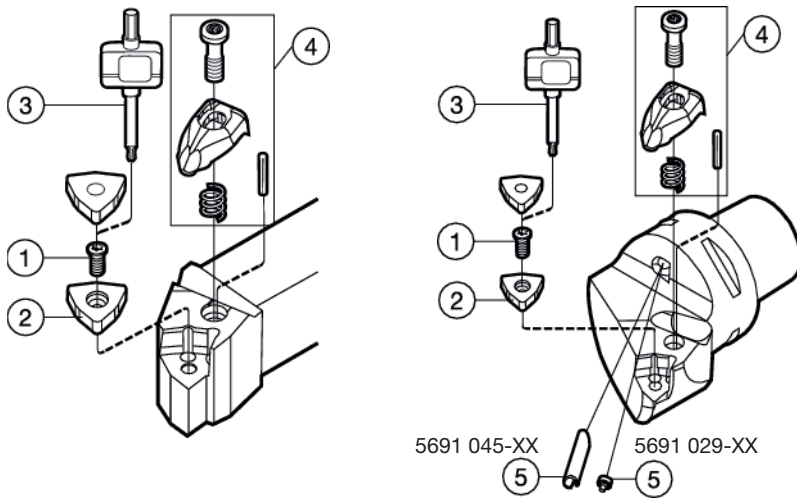

CoroTurn® RC-System



Zoll	Metrisch	Coromant Capto®	1	2	3	4)2)	5
			Schraube für Zwischenlage	Zwischenlage (Für Plattendicke, mm)	Schlüssel (Torx Plus)	Kompletter Spannsatz	Kühlschmierstoffdüse ⁵⁾
							
DCFNR/L 164D			5513 020-02	5322 234-01 (4.76/.187) 5322 234-02 (7.94/.312) ¹⁾	5680 049-01 (15IP)	5412 028-021 5412 034-021 ³⁾ 5412 032-021 ⁴⁾	-
DCGNR/L 164D DCGNR/L 204D			5513 020-02	5322 234-01 (4.76/.187) 5322 234-02 (7.94/.312) ¹⁾	5680 049-01 (15IP)	5412 028-021 5412 034-021 ³⁾ 5412 032-021 ⁴⁾	-
DCLNR/L 103A DCLNR/L 123C DCLNR/L 163D DCLNR/L 104A	DCLNR/L 1616H09 DCLNR/L 2020K09 DCLNR/L 2525M09 DCLNR/L 1616H12	C3-DCLNR/L-22040-09 C4-DCLNR/L-27050-09 - C3-DCLNR/L-22045-12	5513 020-04	5322 236-04 (3.18/.125)	5680 051-03 (9IP)	5412 028-011	-
DCLNR/L 124B DCLNR/L 164C DCLNR/L 164D DCLNR/L 204D DCLNR/L 244DM1 DCLNR/L 854D	DCLNR/L 2020K12 DCLNR/L 2525M12 DCLNR/L 3225P12 DCLNR/L 3232P12 DCLNR/L 4040S12	C4-DCLNR/L-27050-12 C5-DCLNR/L-35060-12 C6-DCLNR/L-45065-12 C8-DCLNR/L-55080-12 -	5513 020-02	5322 234-01 (4.76/.187) 5322 234-02 (7.94/.312) ¹⁾	5680 049-01 (15IP)	5412 028-021 5412 034-021 ³⁾ 5412 032-021 ⁴⁾	5691 045-01 5691 045-01 5691 045-01 -
DCLNR/L 165D DCLNR/L 205D DCLNR/L 245D DCLNR/L 855D	DCLNR/L 2525M16 DCLNR/L 3225P16 DCLNR/L 3232P16	C4-DCLNR/L-27055-16 C5-DCLNR/L-35060-16 C6-DCLNR/L-45065-16 C8-DCLNR/L-55080-16	5513 020-07	5322 234-03 (6.35/.250) 5322 234-04 (7.94/.312) ¹⁾	5680 043-14 (20IP)	5412 028-031 5412 034-031 ³⁾ 5412 032-031 ⁴⁾	5691 045-01 5691 045-01 5691 045-01
DCLNR/L 166D DCLNR/L 206D DCLNR/L 246D DCLNR/L 856D	DCLNR/L 2525M19 DCLNR/L 3232P19 DCLNR/L 3225P19 DCLNR/L 4040S19 DCLNR/L 4040S25 DCLNR/L 5050T25	C5-DCLNR/L-35060-19 C6-DCLNR/L-45065-19 C8-DCLNR/L-55080-19 - C8-DCLNR/L-55080-25 -	5513 020-07 5513 020-08	5322 236-01 (6.35/.250) 5322 234-05 (9.52/.374)	5680 043-14 (20IP) 5680 043-15 (25IP)	5412 028-041 5412 028-051	5691 045-01 5691 045-01 5691 045-01 5691 045-01 -
DCRNR/L 124BM1 DCRNR/L 164DM1 DCRNR/L 204DM1 DCRNR/L 244DM1 DCRNR/L 854D	DCBNR/L 2020K12 DCBNR/L 2525M12 DCBNR/L 3225P12 DCBNR/L 3232P12 DCBNR/L 4040S12	C4-DCRNR/L-22050-12 C5-DCRNR/L-27060-12 C6-DCRNR/L-35065-12 - -	5513 020-02	5322 234-01 (4.76/.187) 5322 234-02 (7.94/.312) ¹⁾	5680 049-01 (15IP)	5412 028-021 5412 034-021 ³⁾ 5412 032-021 ⁴⁾	5691 029-08 5691 045-01 5691 045-01
DCRNR/L 165D DCRNR/L 205D DCRNR/L 245D DCRNR/L 855D	DCBNR/L 2525M16 DCBNR/L 3225P16 DCBNR/L 3232P16 DCBNR/L 4040S16	C5-DCRNR/L-27060-16 C6-DCRNR/L-35065-16 C8-DCRNR/L-55080-16 -	5513 020-07	5322 234-03 (6.35/.250) 5322 234-04 (7.94/.312) ¹⁾	5680 043-14 (20IP)	5412 028-031 5412 034-031 ³⁾ 5412 032-031 ⁴⁾	5691 045-01 5691 045-01 5691 045-01
DCRNR/L 206D DCRNR/L 246D	DCBNR/L 3232P19 DCBNR/L 4040S19	C5-DCRNR/L-27060-19 C6-DCRNR/L-35065-19 C8-DCRNR/L-55080-19	5513 020-07	5322 236-01 (6.35/.250)	5680 043-14 (20IP)	5412 028-041	5691 029-09 5691 045-01 5691 045-01

1) Zusatzteile Lieferung auf gesonderte Bestellung



2) Spannsatzteile siehe Seite A359.

3) Spannsätze für Keramikplatten ohne Bohrung

4) Spannsätze für Keramikplatten mit Bohrung

5) Für optionale Düsen, siehe Seite A359.

CoroTurn® RC-System

			1	2	3	4 ¹⁾²⁾	5				
Zoll	Metrisch	Coromant Capto®	Schraube für Zwischenlage	Zwischenlage (Für Plattendicke, mm)	Schlüssel (Torx Plus)	Kompletter Spannsatz	Kühlschmierstoffdüse ⁶⁾				
			DCKNR/L 124B	DCKNR/L 2020K12	C4-DCKNR/L-27050-12	5513 020-02	5322 234-01 (4.76/.187)	5680 049-01 (15IP)	5412 028-021	5691 029-08	
			DCKNR/L 164D	DCKNR/L 2525M12	C5-DCKNR/L-35060-12		5322 234-02 (7.94/.312) ¹⁾		5412 034-021 ³⁾	5691 029-09	
			DCKNR/L 854D	DCKNR/L 3225P12	C6-DCKNR/L-45065-12				5412 032-021 ⁴⁾	5691 029-09	
			DCKNR/L 205D	DCKNR/L 3232P16	C4-DCKNR/L-27050-16	5513 020-07	5322 234-03 (6.35/.250)	5680 043-14 (20IP)	5412 028-031	5691 045-01	
				DCKNR/L 4040S16	C5-DCKNR/L-35060-16		5322 234-04 (7.94/.312) ¹⁾		5412 034-031 ³⁾	5691 029-09	
					C6-DCKNR/L-45065-16				5412 032-031 ⁴⁾	5691 029-09	
					C6-DCKNR/L-45065-19	5513 020-07	5322 236-01 (6.35/.250)	5680 043-14 (20IP)	5412 028-041	5691 029-09	
					C8-DCKNR/L-55080-19					5691 029-09	
DCGNR/L 164D			5513 020-02	5322 234-01 (4.76/.187)	5680 049-01 (15IP)	5412 028-021					
DCGNR/L 204D				5322 234-02 (7.94/.312) ¹⁾		5412 034-021 ³⁾					
DCGNR/L 206D						5412 032-021 ⁴⁾					
DCGNR/L 246D			5513 020-07	5322 236-01 (6.35/.250)	5680 043-14 (20IP)	5412 028-041					
				C5-DCMNN-00105-12	5513 020-02	5322 234-01 (4.76/.187)	5680 049-01 (15IP)	5412 028-021	5691 029-09		
				C6-DCMNN-00090-12		5322 234-02 (7.94/.312) ¹⁾		5412 034-021 ³⁾	-		
				C6-DCMNN-00115-12				5412 032-021 ⁴⁾	5691 029-10		
				C6-DCMNN-00090-16	5513 020-07	5322 234-03 (6.35/.250)	5680 043-14 (20IP)	5412 028-031	-		
				C8-DCMNN-00150-16		5322 234-04 (7.94/.312) ¹⁾		5412 034-031 ³⁾	5691 029-10		
								5412 032-031 ⁴⁾			
			DDHNR/L 2020K15			C4-DDHNR/L-27055-15	5513 020-02	5322 266-02 (6.35/.250)	5680 049-01 (15IP)	5412 028-021	5691 045-01
			DDHNR/L 2525M15			C5-DDHNR/L-35060-15		5322 266-01 (4.76/.187) ¹⁾		5412 034-021 ³⁾	5691 045-01
DDHNR/L 3225P15			C6-DDHNR/L-45065-15		5322 266-03 (7.94/.312) ¹⁾		5412 032-021 ⁴⁾	5691 045-01			
DDHNR/L 3232P15			C8-DDHNR/L-55080-15					5691 045-01			
DDJNR/L 103A			C3-DDJNR/L-22045-11	5513 020-04	5322 267-01 (4.76/.187)	5680 051-03 (9IP)	5412 028-011	5691 045-01			
DDJNR/L 123C			C4-DDJNR/L-27050-11					5691 029-08			
DDJNR/L 163D			C5-DDJNR/L-35060-11					5691 029-09			
DDJNR/L 203D			C6-DDJNR/L-45065-11					5691 029-09			
DDJNR/L 243D			-					-			
DDJNR/L 853D											
DDJNR/L 124B				5513 020-02	5322 266-01(4.76/.187)	5680 049 (15IP)	5412 028-021				
DDJNR/L 164C					5322 266-02 (6.35/.250) ¹⁾						
DDJNR/L 164D					5322 266-03 (7.94/.312) ¹⁾						
DDJNR/L 204D					5322 266-04 (4.76/.187) ⁵⁾						
DDJNR/L 244D											
DDJNR/L 854D											
DDJNR/L 2020K15			C4-DDJNR/L-27055-15	5513 020-02	5322 266-02 (6.35/.250)	5680 049-01 (15IP)	5412 028-021	5691 029-08			
DDJNR/L 2525M15			C5-DDJNR/L-35060-15		5322 266-01 (4.76/.187) ¹⁾		5412 034-021 ³⁾	5691 045-01			
DDJNR/L 3225P15			C6-DDJNR/L-45065-15		5322 266-03 (7.94/.312) ¹⁾		5412 032-021 ⁴⁾	5691 029-09			
DDJNR/L 3232P15			C8-DDJNR/L-55080-15					5691 029-10			
DDJNR/L 4040S15			-					-			
			C4-DDUNR/L-27050-15	5513 020-02	5322 266-02 (6.35/.250)	5680 049-01 (15IP)	5412 028-021	5691 029-09			
			C5-DDUNR/L-35060-15		5322 266-01 (4.76/.187) ¹⁾		5412 034-021 ³⁾	5691 029-09			
			C6-DDUNR/L-45065-15		5322 266-03 (7.94/.312) ¹⁾		5412 032-021 ⁴⁾	5691 029-10			
			C8-DDUNR/L-55080-15					5691 029-10			
DDPNN 123B			C4-DDNNN-00050-11	5513 020-04	5322 267-01 (4.76/.187)	5680 051-03 (9IP)	5412 028-011	5691 029-08			
DDPNN 163C			C5-DDNNN-00060-11					5691 045-01			
DDPNN 124B			C4-DDNNN-00055-15	5513 020-02	5322 266-02 (6.35/.250)	5680 049-01 (15IP)	5412 028-021	5691 029-08			
DDPNN 164D			C5-DDNNN-00060-15		5322 266-01 (4.76/.187) ¹⁾		5412 034-021 ³⁾	5691 045-01			
DDPNN 204D			C6-DDNNN-00065-15		5322 266-03 (7.94/.312) ¹⁾		5412 032-021 ⁴⁾	5691 045-01			
			C8-DDNNN-00080-15					5691 045-01			
			C5-DDMNL-00115-15	5513 020-02	5322 266-02 (6.35/.250)	5680 049-01 (15IP)	5412 028-021	5691 029-09			
			C6-DDMNL-00130-15		5322 266-01 (4.76/.187) ¹⁾		5412 034-021 ³⁾	5691 029-10			
			C6-DDMNL-33120-15		5322 266-03 (7.94/.312) ¹⁾		5412 032-021 ⁴⁾	-			
			C8-DDMNL-00160-15					5691 029-10			
DDQNR/L 123B				5513 020-04	5322 267-01 (4.76/.187)	5680 051-03 (9IP)	5412 028-011				
DDQNR/L 164D				5513 020-02	5322 266-01 (4.76/.187)	5680 049-01 (15IP)	5412 028-021				
DDQNR/L 204D					5322 266-02 (6.35/.250) ¹⁾		5412 034-021 ³⁾				
DDQNR/L 244D					5322 266-03 (7.94/.312) ¹⁾		5412 032-021 ⁴⁾				
					5322 266-04 (4.76/.187) ⁵⁾						



1) Zusatzteile Lieferung auf gesonderte Bestellung
 2) Spannsatzteile siehe Seite A359.
 3) Spannsätze für Keramikplatten ohne Bohrung
 4) Spannsätze für Keramikplatten mit Bohrung
 5) Für Wendeschneidplatten mit Schneidenradius 0.016-0.031
 6) Für optionale Düsen, siehe Seite A359.

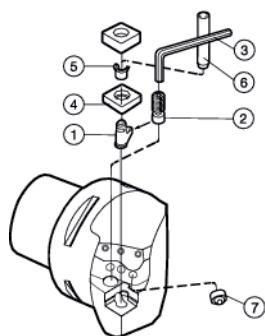

CoroTurn® HP

Hebelspannsystem



	1	2
Coromant Capto®	Kniehebel	Schraube
		
C4-PCLNR/L-27050-12HP C5-PCLNR/L-35060-12HP C6-PCLNR/L-45065-12HP C6-PCLNR/L-45165-12HP C8-PCLNR/L-55080-12HP C6-PCMNN-00115-12HP C8-PCMNN-00150-12HP	174.3-841M	174.3-821
C5-PCLNR/L-35080-16HP C6-PCLNR/L-35065-16HP C8-PCLNR/L-55080-16HP C8-PCLNR/L-35085-16HP	438.3-840	438.4-831
C6-PCLNR/L-45065-19HP C8-PCLNR/L-55080-19HP C6-PCRNR/L-35065-19HP	174.3-842M	174.3-822M
		
C4-PDJNR/L-27055-15HP C5-PDJNR/L-35060-15HP C6-PDJNR/L-45165-15HP C5-PDMNR/L-00130-15HP C6-PDJNR/L-45065-15HP	174.3-847M	174.3-830
C5-PDJNR/L-35080-1504HP C8-PDJNR/L-45065-1504HP C8-PDJNR/L-55080-1504HP	174.3-847M 174.3-847M	174.3-830 174.3-830
		
C5-PSSNR/L-35052-12HP C6-PSSNR/L-45156-12HP C6-PSSNR/L-45056-12HP C8-PSSNR/L-55080-12HP	174.3-841M	174.3-821
C6-PSDNN-00065-15HP C6-PSKNR/L-45065-15HP C6-PSRNR/L-35065-15HP C5-PSSNR/L-35050-15HP C6-PSSNR/L-45054-15HP C8-PSSNR/L-55080-15HP	438.3-840	438.3-831
C6-PSDNN-00065-19HP C6-PSKNR/L-35065-19HP C8-PSKNR/L-55080-19HP C6-PSRNR/L-35065-19HP C8-PSRNR/L-45080-19HP C6-PSSNR/L-45052-19HP C8-PSSNR/L-55080-19HP	174.3-842M	174.3-822M

CoroTurn® HP

3	4		5	6	7
Schlüssel (mm)	Zwischenlage (Für Plattendicke, mm)	Radius mm/Zoll	Rohrstift für Zwischenlage	Montagedorn	Düse (Bohrungsdurchmesser, mm) ²⁾
174.1-864 (3.0)	171.31-850M (4.76/.187)	0.4-1.6/.016-.063	174.3-861	5681 002-01	5691 026-03 (1.0)
174.1-864 (3.0)	171.31-852 (6.35/.250)	0.4-2.4/.016-.094	174.3-864	5681 002-02	5691 026-03 (1.0)
3021 010-040 (4.0)	171.35-851M (6.35/.250)	0.4-2.4/.016-.094	174.3-861	5681 002-02	5691 026-03 (1.0)
174.1-864 (3.0)	171.35-851M (6.35/.250) 171.35-850M (6.35/.250) ¹⁾ 171.35-856 (4.76/.187) ¹⁾ 171.35-855 (4.76/.187) ¹⁾	0.4-0.8/.016-.031 1.2-1.6/.047-.063 0.4-0.8/.016-.031 1.2-1.6/.047-.063	174.3-861	5681 002-01	5691 026-03 (1.0)
174.1-864 (3.0)	171.35-856 (4.76/.187)		174.3-861	5681 002-01	5691 026-03 (1.0)
174.1-864 (3.0)	171.35-851M (6.35/.250)		174.3-861	5681 002-01	5691 026-03 (1.0)
174.1-864 (3.0)	174.3-851M (4.76/.187) 171.35-856 (4.76/.187) ¹⁾	0.4-1.2/.016-.047 1.6-2.4/.063-.094	174.3-861	5681 002-01	5691 026-03 (1.0)
174.1-864 (3.0)	174.3-857 (6.35/.250)	0.4-2.4/.016-.094	174.3-864	5681 002-02	5691 026-03 (1.0)
3021 010-040 (4.0)	174.3-852M (6.35/.250)	0.8-2.4/.031-.094	174.3-862	5681 002-02	5691 026-03 (1.0)

1) Zubehör ist gesondert zu bestellen.

2) Optionale Düsen
Separat zu bestellen

Bestellnummer	Bohrungsdurchmesser, mm
5691 026-01	0.6
5691 026-02	0.8
5691 026-04	1.2
5691 026-05	1.4